



DATI TECNICI - Technical data

corrente nominale	rated operating current	12A
tensione nominale	rated voltage	690V
tensione di isolamento	insulation voltage	690V
tensione ad impulso	impulse withstand voltage	4kV
temperatura di funzionamento	operating temperature	-25 +55 °C
temperatura di magazzino	storage temperature	-30 +70 °C
morsetti a vite	screw terminals	M3.5 2x2,5mm ²
grado di protezione comando	control protection degree	IP65
grado di protezione morsetti	terminals protection degree	IP65
costruzione a norme	manufactured according to	IEC DIN UL

TIPO - Type

DIMENSIONI - Dimensions

Descrizione - Description	Codice - Code
VOLTMETRICO: Fase-Fase (4 posizioni) VOLTAGE: Phase-Phase (4 position)	L48EV3
VOLTMETRICO: Fase-Fase/Fase-Neutro (7 posizioni) VOLTAGE: Phase-Phase/Phase-Neutral (7 position)	L48ET3
AMPEROMETRICO: Unipolare prer 3 TA (4 posizioni) CURRENT: Single-pole for 3 CT's (4 position)	L48EA
ACCESSORIO: Cuffia di protezione morsetti ACCESSORY: Protective cap for terminals	9SBMCL

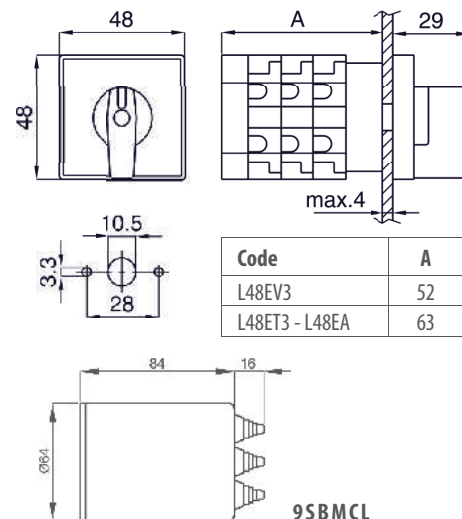

SCHEMI DI INSERIMENTO - Wiring diagrams

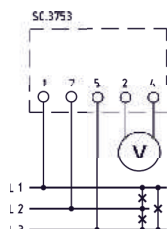
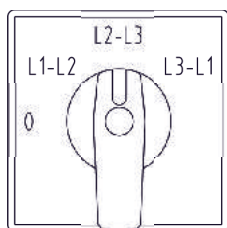

L48EV3

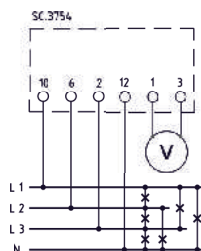
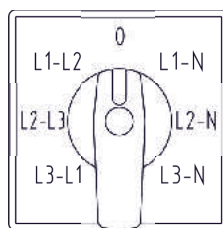

L48ET3

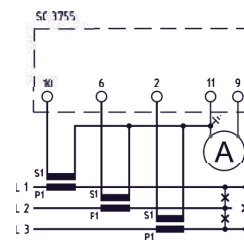
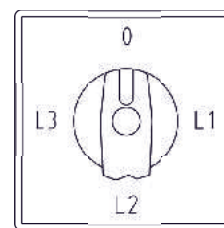

L48EA